

Performance curves

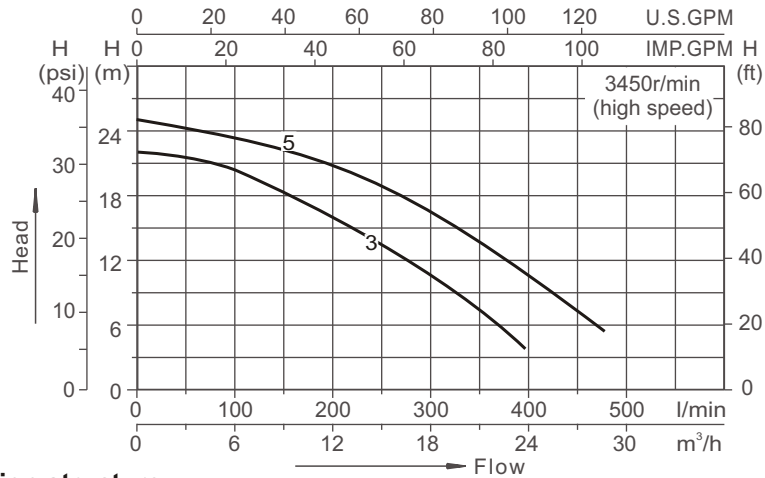

Installation structure

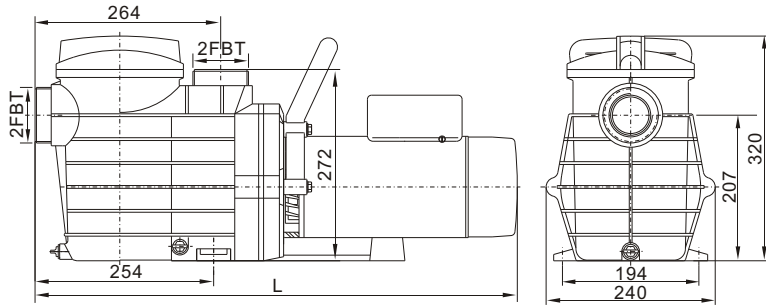

Model	V/Hz	Amps (A)	Power (kW)	Fitting size (mm)	Qmax (l/min)	Hmax (m)	Curves
48SUP1003C-I	115/230-60	12/6	1.5	60.3or63	400	22	3
48SUP1653C-I	115/230-60	17/8.5	1.85	60.3or63	480	25	5

liquid temperature: 4°C ~ 50°C  
 Storage temperature: -10°C ~ +50°C.  
 Relative Air Humidity: 95% Max.

Edition: 2019-12 ④



**SWIMMING POOL PUMPS  
 INSTRUCTION  
 MANUAL**

**IMPORTANT SAFETY  
 INSTRUCTIONS.**

When installing and using this electrical equipment, basic safety precautions should always be followed, including the following:

- 1) READ AND FOLLOW ALL INSTRUCTIONS**
- 2) WARNING- To reduce the risk of injury, do not permit children to use this product Unless they are closely supervised at all times.**
- 3) SAVE THESE INSTRUCTIONS**

**1.General**

These instructions are for correct installation, and optimum performance of the Bath pumps, so they should be read carefully. These are single-stage centrifugal pumps designed to operate with compact hydromassage equipment, They are equipped with a total-emptying system to prevent the discharge of residual liquid in each stopping.

These units are designed to operate with clean water at a maximum water temperature of 50°C. Built of top quality materials, they are subjected to strict hydraulic and electrical controls and are carefully verified. Correct installation is ensured by following these instructions and those of the wiring diagram; otherwise, over loads may be produced in the motor. We decline responsibility for any damage caused by not following these instructions.

**2.Installation**

The pumps should be installed horizontally, securing them with screws through the holes in the supports to prevent undesirable noise and vibration.

The suction, pipe of the pump should be as short as possible.

The rating Label must be visible after installation. Parts containing live parts, except parts supplied with safety extra low voltage <12V, must be inaccessible to a person in the bath. Class I appliances must be permanently connected to fixed wiring. Part including electrical components except remote control devices must be located or fixed so that they cannot into bath.

### 3. Pipe Assembly

The suction and discharge pipes should have a diameter equal to or greater than that of the intake tapping of the pump.

Avoid traps as, in addition to affecting efficiency, they impede total overall emptying.

The suction and discharge pipes should not rest on the pump in any case.

Seal all the connectors and unions well. Avoid any dripping on the motor, which would unfailingly damage it.

### 4. Electrical connection

The electrical installation should have a multiple separation system with contacts opening at least 3mm.

 For continued protection against possible electric shock this unit is to be mounted to the base in accordance with the installation instructions.

The protection of the system should be based on a residual current device (RCD) with a rated tripping current not exceeding 30mA. The supply cable should comply with EMC standards (2). Single-phase motors have built-in thermal protection. When the pump runs under abnormal conditions and causes the thermal protector to work, please cut off the pump power if it is at the low speed (1450r/min) and plug in 1 minute later. If the pump is at the high speed (2900r/min), it will start work again when the thermal protector resets automatically as the motor temperature drops to a certain degree.

The diagrams in Fig. (1) correct electrical connection. The electric connection must be carried out by qualified staff following strictly the "UL1563、UL1081" standard.

Be sure that the grounding connection is correctly made. The grounding conductor shall not be smaller than NO.12AWG(3.3mm<sup>2</sup>)

Be sure that the equipotential connection between the bath and the pump is correctly made. Wires serving as equipotential bonding conductors shall have a cross-sectional area between 2.5 and 6mm<sup>2</sup> and shall be equipped with the terminal suitable receptacle.

### 5. Controls Prior to Initial Start-up

 Verify that the pump shaft turns freely.

Check that the mains voltage and frequency are according to the name plate.

The hydromassage assembly should be equipped with a system to prevent the pump from starting up if a minimum water level is not present.

Check the rotating direction of the motor, which should concur with that indicated on the fan cover.

If the motor does not start up, try to locate the problem in the table of most common faults and their possible solutions that is provided further on.

THE PUMP SHOULD NEVER OPERATE DRY.

### 6. Start-up

Start electrically the pump only when the suction and discharge pipes are connected to the corresponding inlets and outlets. Check that there is no obstacle in the pipes.

Apply voltage to the motor and suitably adjust the jets to obtain the desired flow.

### 7. Maintenance and clean

 Our pumps for hydromassage facilities do not require any special maintenance or programming.

If the pump will be idle for a long period of time, it is recommended to disassemble, clean and store it in a dry, well-ventilated place. If the supply cord is damaged, it must be replaced by the manufacturer or its service agent or a similarly qualified person to a hazard.

Pump can be automatically empty water after correct installation.

When the pump needs to clean (1) filling with water up to level position of bathtub's nozzle, (2) operating 2-3 minutes, (3) exhausting water of bathtub after engine stop.

### 8. Trouble Shooting Guide

SYMPTOM	POSSIBLE CAUSE	CHECK
PUMP DOES NO TURN	NO POWER TO PUMP	-incoming power to the pump? -Is circuit breaker on? -Is GFCI operating properly? -Is the air switch plugged in?
	AIR SWITCH DISCONNECTED	-Is the air switch hose connected to the pump? -Is the air switch hose connected to the actuator button on the tub deck?
PUMP NOT PUMPING PROPERLY	BLOCKAGE OR LEAK	-Jets should be pointed away from the suction inlet so air is not forced into pump suction -Is the in-tub suction inlet blocked or covered? -Is there any debris in the pump housing? -Is there a leak in the piping or the pump?
	LOW VOLTAGE	-Is the proper voltage applied to the pump? -Is there an extension cord being used?

### Installation circuit diagram

As the colours of the wires in the mains lead of this appliance may not correspond with the coloured markings identifying the terminals in your connection unit proceed as follows.

The wire which is coloured green must be connected to the terminal in the connection unit which is marked with the letter E or by the earth symbol ⊕ or coloured green or green-and-yellow.

Black wire and White wire connected with power supply is low speed.

Red wire and White wire connected with power supply is high speed.

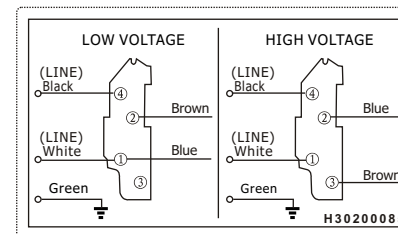

48SUP1003C-I

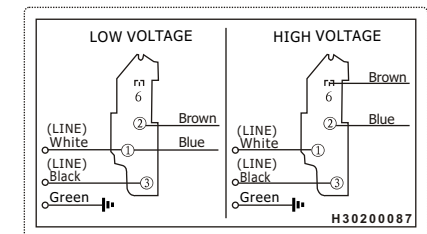

48SUP1653C-I